

Схема сборки

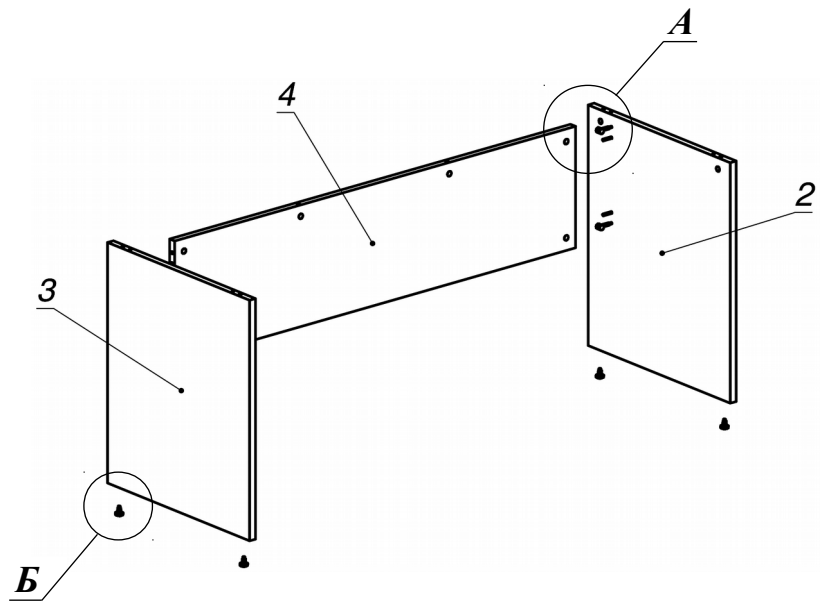

Вид А

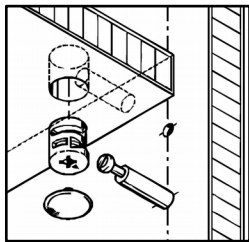

Вид Б

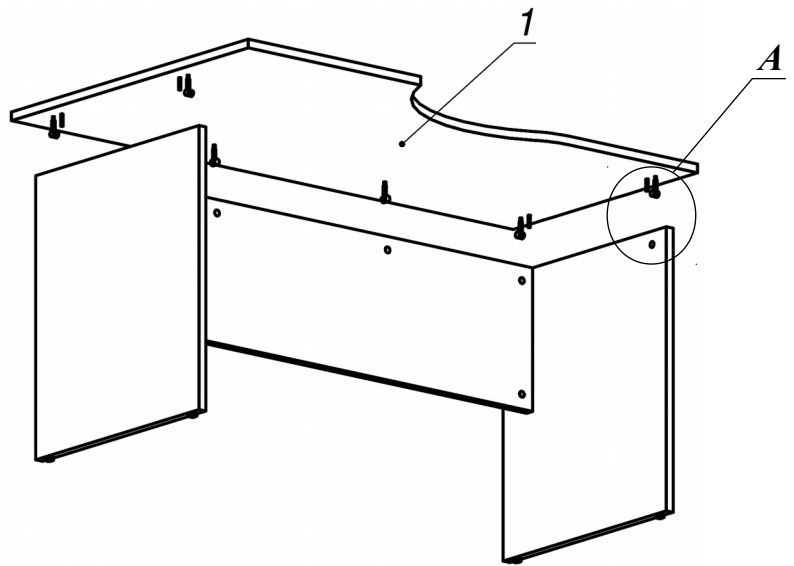
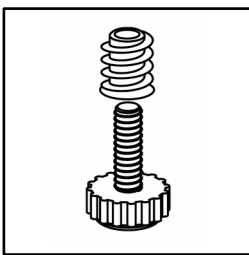

Спецификация расхода фурнитуры

10 шт.  Стяжка Minifix - ДЮБЕЛЬ - 34	10 шт.  Стяжка Minifix - ЗАГЛУШКА (пласт.)	10 шт.  Стяжка Minifix - ЭКСЦЕНТРИК - 22/d15/без покр.	8 шт.  Шкант d6x30/бук
---	---	---	---

Спецификация по деталям

Поз.	Кол., шт.	Название	h, мм	Размер габ., мм x мм
1	1	Столешница	22	900 x 1600
2	1	Опора лв.	22	620 x 720
3	1	Опора пр.	22	620 x 720
4	1	Царга	22	364 x 1468

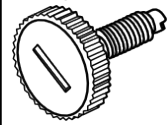
4 шт.  Муфта к опоре регулир. PERMO d17xh8(+10)	4 шт.  Опора регулир. PERMO d17xh8(+10)
--	---