

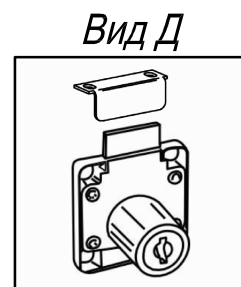

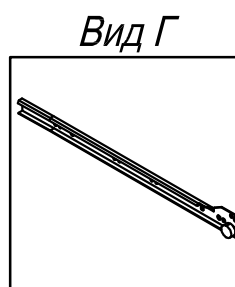

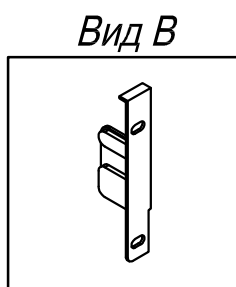

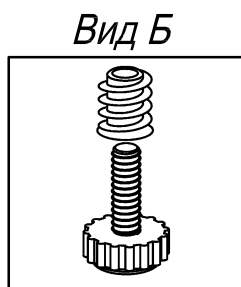

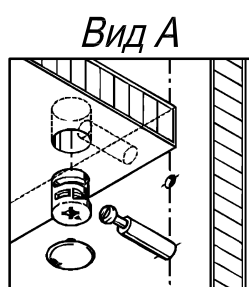
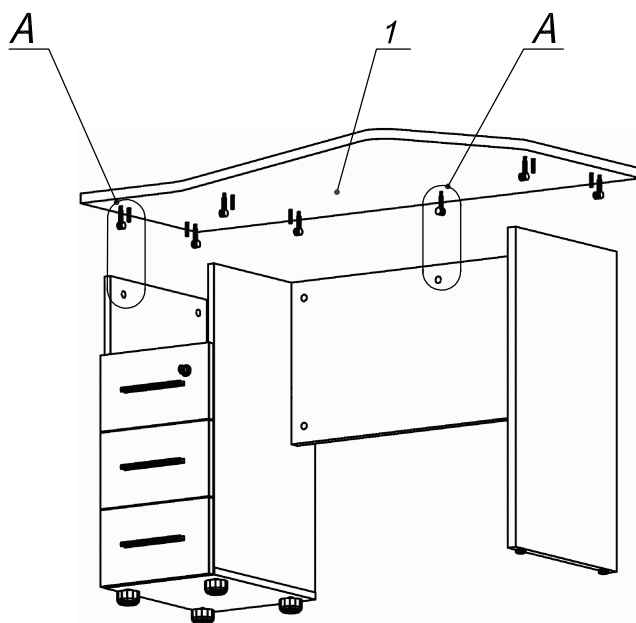
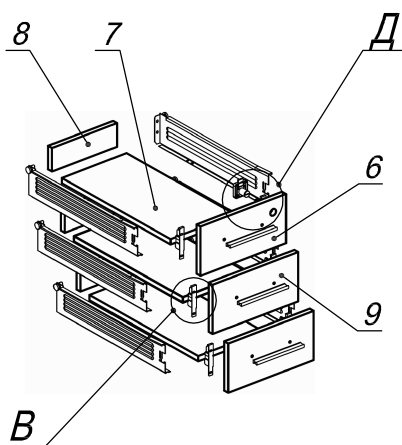
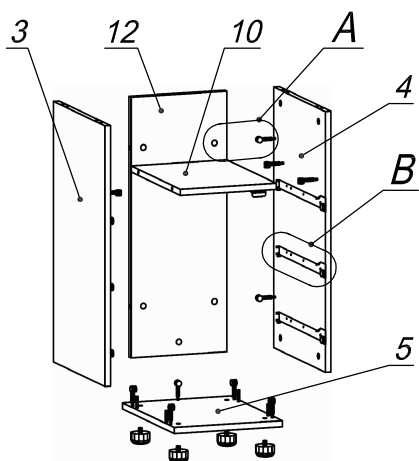
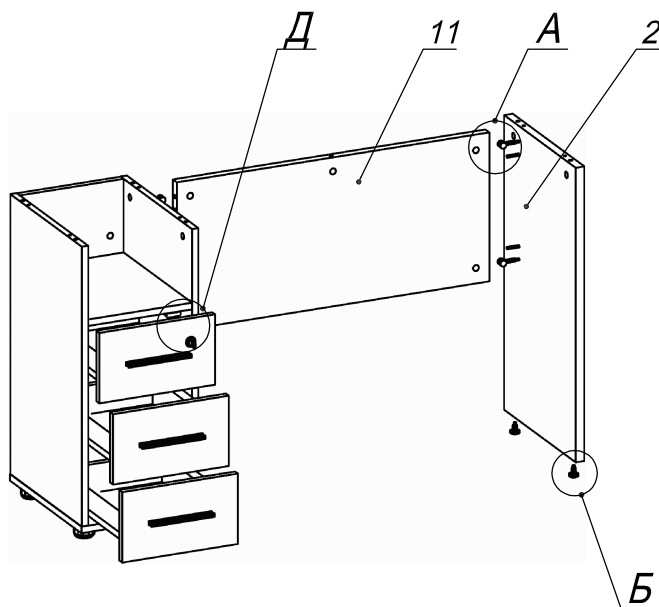
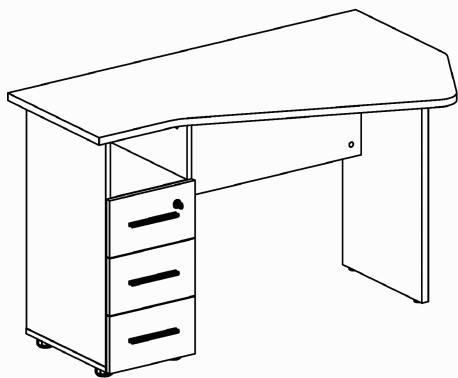

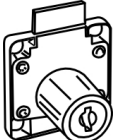

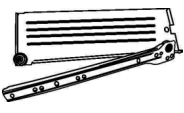

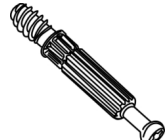

*Схема сборки*

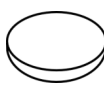
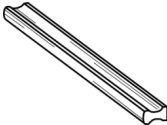
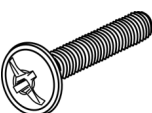

Спецификация по деталям

Поз.	Кол., шт.	Название	h, мм	Размер габ., мм x мм
1	1	Столешница	22	1200 x 750
2	1	Опора пр.	22	720 x 390
3	1	Бок т. лв.	16	684 x 390
4	1	Бок т. пр.	16	684 x 390
5	1	Дно	16	298 x 390
6	1	Фасад 1	16	294 x 172
7	3	Дно ящика	16	348 x 232
8	3	Задняя ст. ящика	16	70 x 232
9	2	Фасад 2	16	294 x 172
10	1	Полка	16	264 x 373
11	1	Царга	22	794 x 364
12	1	З/стенка	16	684 x 264

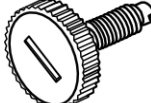
Спецификация расхода фурнитуры

1 шт.  Замок накладной СТАНДАРТ	1 шт.  Ответная планка к замку СТАНДАРТ	3 компл.  Направляющие Sambox 86x350	6 шт.  СТЯЖКА Sambox 86	17 шт.  Стяжка Minifix - ЭКСЦЕНТРИК - 16/d15/без покр.	7 шт.  Стяжка Minifix - ЭКСЦЕНТРИК - 22/d15/без покр.	24 шт.  Стяжка Minifix - ДЮБЕЛЬ - 34
24 шт.  Стяжка Minifix - ЗАГЛУШКА (пласт.)	14 шт.  Шкант d6x30/бук	6 шт.  Демпфер двери	3 шт.  Ручка "UA03" СТАНДАРТ L128 (алюм.)	6 шт.  Винт M4x20/с бурт.	2 шт.  Саморез d3,0x13/потайной	36 шт.  Саморез d3,5x16/потайной
4 шт.  Саморез d3,5x20/потайной	18 шт.  Саморез d4,0x16/потайной	2 шт.  Муфта к опоре регулир. PERMO d17xh8(+10)	2 шт.  Опора регулир. PERMO d17xh8(+10)	4 шт.  Опора регулир. PERMO d49xh28(+20)		